



THE ISA-CHINA JOINT TRAINING
AND RESEARCH CENTRE

中国-国际海底管理局
联合培训和研究中心

ANNUAL REPORT 2022

2022年 年度报告



THE ISA-CHINA JOINT TRAINING
AND RESEARCH CENTRE



ANNUAL REPORT 2022

CONTENTS

目录

2
Acknowledgment

致谢

3
Acronyms

缩略语

4 | 18
Foreword by the
Secretary-General
of the International
Seabed Authority

国际海底管理局
秘书长致辞

7 | 21
Activities highlights

活动亮点

● The first JTRC
training workshop
联合中心第一期培训班

● Third meeting of
the JTRC Steering
Committee
联合中心指导委员会第
三次会议

12 | 26
Work plan for 2023

2023年工作计划

● The first joint JTRC
research programme
联合中心第一期研究项目

● The second JTRC
training workshop
联合中心第二期培训班

5 | 19

Foreword by the Vice
Minister and Administrator
of the Ministry of Natural
Resources (State Oceanic
Administration) of China

中国自然资源部副部
长兼国家海洋局局长
致辞



Design and planning
of JTRC research
activities

联合中心研究活动设计
和规划

13 | 27

Annex 1.
JTRC training
workshop opening
remarks

联合中心第一期
培训班开幕致辞

6 | 20

International Seabed
Authority - China Joint
Training and Research
Centre 2022

中国-国际海底管理局
联合培训和研究中心
2022

12 | 26

Finance and resources

资金和资源

14 | 28

Annex 2.
JTRC training
workshop agenda

联合中心第一期培
训班日程

ACKNOWLEDGMENT 致谢

This annual report was produced by the Joint Training and Research Centre with support from the Secretariat of the International Seabed Authority. Special thanks go to the Communications Unit of the Secretariat for their editorial, graphic and production work.

Artwork and design

This annual report was designed by Anish Bajracharya.

Photography

Front cover: Image courtesy of National Deep Sea Centre of China

The latest version of this document is available on the ISA website at: <https://www.isa.org.jm/publications/isa-jtrc-annual-report-2022>

For additional information or feedback on this annual report, please write to us at jtrc@isa.org.jm

© ISA 2023. All rights reserved.

本年度报告由联合培训和研究中心在国际海底管理局秘书处的支持下编写。特别感谢秘书处宣传团队在编辑、平面设计、制作方面开展的工作。

艺术设计

本年度报告由阿尼什·巴杰拉查里亚设计。

摄影

封面照片由中国国家深海基地管理中心提供。

本文件最新版本可查阅海管局网站：
<https://www.isa.org.jm/publications/isa-jtrc-annual-report-2022>

有关本年度报告的更多信息或反馈，
请发邮件至 jtrc@isa.org.jm

© 海管局 2023. 版权所有。

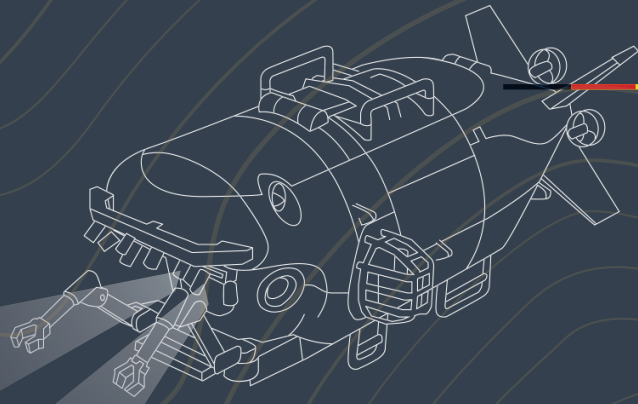

ACRONYMS

COMRA	China Ocean Mineral Resources Research and Development Association
ISA	International Seabed Authority
JTRC	ISA - China Joint Training and Research Centre
LTC	Legal and Technical Commission
MNR	Ministry of Natural Resources of China
UNCLOS	United Nations Convention on the Law of the Sea

缩略语

COMRA	中国大洋矿产资源研究开发协会
ISA	国际海底管理局
JTRC	中国-国际海底管理局联合培训和研究中心
LTC	法律与技术委员会
MNR	中国自然资源部
UNCLOS	联合国海洋法公约

FOREWORD

It is with great pleasure that I present the International Seabed Authority - China Joint Training and Research Centre annual report for the year 2022, which for its second year in operation, was able to organize its first concrete activities successfully.

In May 2022, the International Seabed Authority - China Joint Training and Research Centre held its first training workshop. It brought together leading experts from various fields, including marine biology, oceanography, geology and technology, to share their knowledge, insights and practical experiences on the exploration of the deep sea. The training workshop was an excellent platform to discuss and deliberate on three key areas of activity within the International Seabed Authority's mandate under the United Nations Convention on the Law of the Sea and the 1994 Agreement: survey and assessment of mineral resources in the Area, characteristics of deep-sea ecosystems and environmental management and global repository of data from exploration activities in the Area. More than 50 trainees from 20 countries attended, including 45 per cent from least developed countries, landlocked developing countries and small island developing countries. I am particularly satisfied that most indicated that this event provided many benefits.

We look forward to the next year with great enthusiasm and optimism, confident that we will continue to make significant contributions.

Mr. Michael W. Lodge
Secretary-General
International Seabed Authority

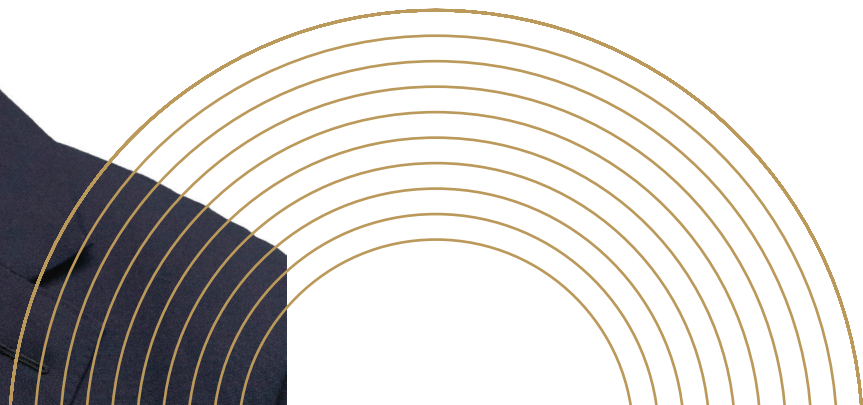

FOREWORD

In 2022, notwithstanding the impact of the global COVID-19 pandemic and thanks to the joint efforts of both sides, the ISA - China Joint Training and Research Centre (JTRC) successfully held the first training workshop online since its establishment. By bringing together leading experts in international deep-sea field, the workshop provided more than 50 trainees from 20 developing countries with diverse, timely and interactive lectures, making a positive contribution to enhancing the capacity of developing countries to participate in international seabed affairs. At the same time, it laid a solid foundation for both sides to conduct joint research in the future.

Going forward, China stands ready to work with the ISA to support the development and advancement of the JTRC, strengthen friendly cooperation with countries around the world, and promote more comprehensive, systematic, and in-depth knowledge of the international seabed area. Under the auspices of the Steering Committee, we expect the JTRC to aggregate global resources, engage renowned international lecturers, and provide more impactful training for future trainees from developing countries. We also expect the JTRC to collaborate with specialized international teams to carry out collaborative research on major scientific topics in the deep-sea field and deepen practical cooperation.

Let us work together to elevate our activities in the international seabed area to a new level!

Mr. Wang Hong

Vice Minister and Administrator, Ministry of Natural Resources (State Oceanic Administration) of the People's Republic of China



ISA - CHINA JOINT TRAINING AND RESEARCH CENTRE 2022

After its official launch in November 2020, the International Seabed Authority (ISA) - China Joint Training and Research Centre (JTRC) concluded its second year of operation. The JTRC has made steady progress in its development owing to the close involvement and active facilitation of its operations by ISA and the Ministry of Natural Resources (MNR) of China.

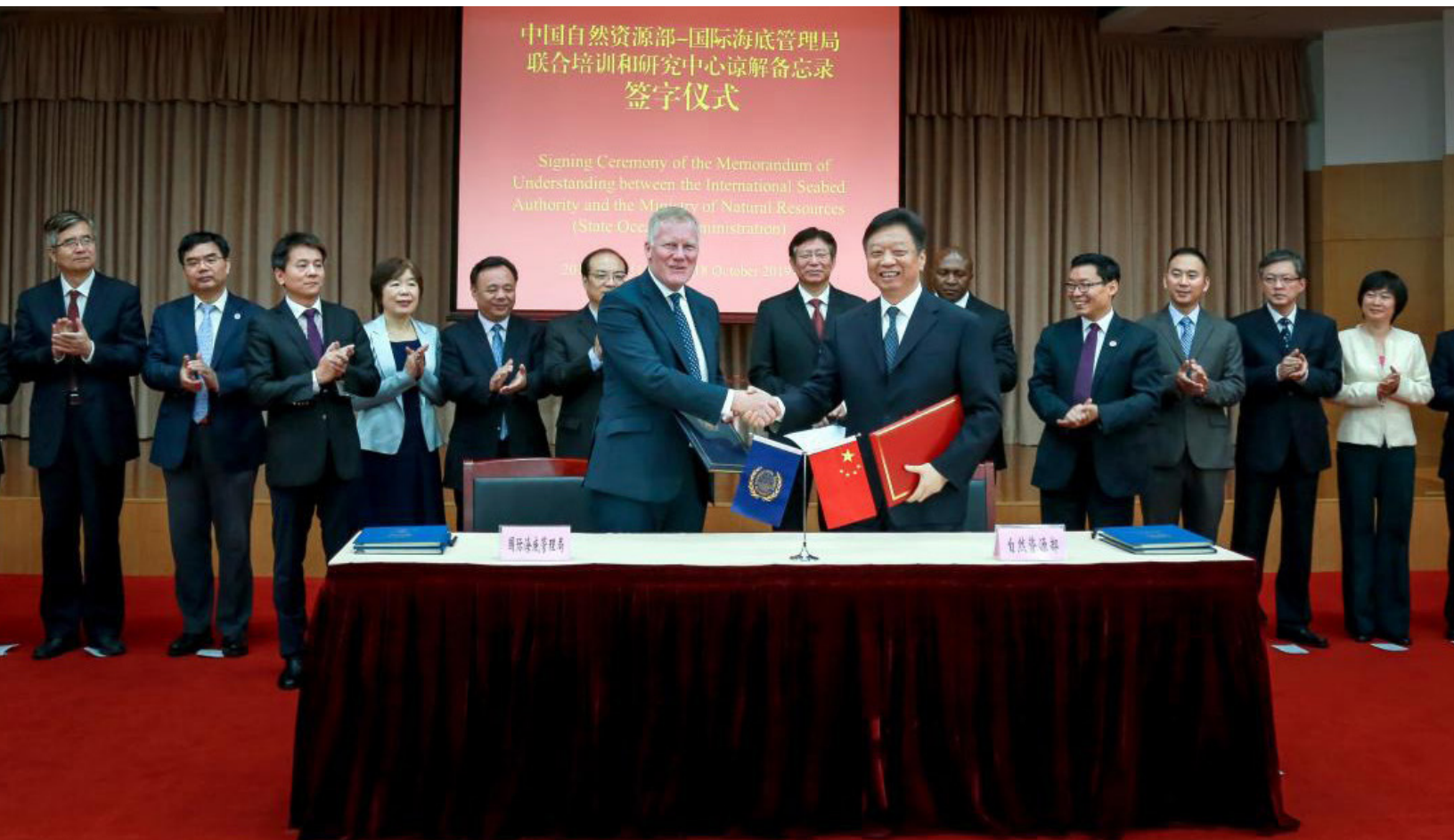

01.

ACTIVITIES HIGHLIGHTS 2022

1.1. The first JTRC training workshop

The first JTRC training workshop took place virtually from 24 to 26 May 2022. It focused on the survey and assessment of mineral resources, the characteristics of deep-sea ecosystems and environmental management, and the global repository of data from exploration activities in the Area.

The training involved 55 participants from 20 countries. This number included 45 per cent of nationals from the least developed countries, landlocked developing countries and small island developing States, and 45 per cent of women.

In his welcome address, the Secretary-General of ISA, H.E. Mr. Michael W. Lodge, reiterated that ISA attaches great importance to partnerships in delivering meaningful capacity development activities to address the priority needs of developing Member States of ISA.

“I attach particular importance to this training workshop as it has been designed to respond to capacity development needs identified by our Member States. It is my firm belief that ISA Member States must be given the opportunity to access high-quality, transformative knowledge, learn with and from each other, and apply their new understanding to real-life scenarios in the Area and beyond to ensure the fully integrated participation of developing States in activities in the Area at all levels.”

The Vice Minister of Natural Resources (Administrator of Oceanic Administration) of China, Mr. Wang Hong, added: “Due to the complexities and challenges of the COVID-19 pandemic, we are holding the first training workshop of the JTRC online. This speaks volumes about the commitment and determination of the Chinese government and ISA to jointly promote capacity-building and science and technology exchanges in deep-sea sciences among developing countries” (see Annex 1 for full statements).

The three-day training workshop consisted of nine lectures. The lecturers came from the ISA Secretariat, the Legal and Technical Commission (LTC), the Hong Kong University of Science and Technology, the Office of the China Ocean Mineral Resources Research and Development Association (COMRA), the Second Institute of Oceanography of the MNR, and the National Marine Data and Information Service. Ten young experts from the MNR’s First Institute of Oceanography, Changsha Research Institute of Mining and Metallurgy, the Ocean University of China, the China Ship Scientific Research Centre and the China University of Mining and Technology served as facilitators during breakout discussions. Trainees from different countries engaged in active and lively group discussions and interactions on the training topics (see Annex 2 for the agenda).



The First Training Workshop of ISA - China Joint Training and Research Center Mineral resources, environmental management and data

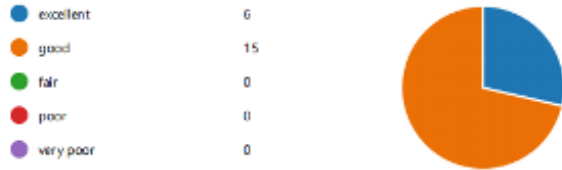

Photo 1. The workshop trainees and trainers

Following the conclusion of the training workshop, the ISA Secretariat surveyed the quality, practicality and the added value of the training activities for capacity-building in developing countries. Twenty-one international trainees answered the bespoke survey. Over 90 per cent of respondents assessed the workshop as “excellent” or “good.” They also shared

that the training workshop was tailored to the needs of capacity-building in developing countries, the topics covered were related to frontiers and hot issues in the Area, the training programme was rich in content and diverse in format and had a positive impact on international research and management in the field of deep-sea scholarship.

17. How would you rate the teaching and learning methodology the experts and facilitators applied during the training workshop?



20. How would you rate the quality of the training materials?

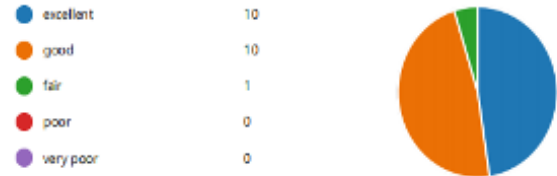

18. How would you rate the knowledge and expertise of the experts (lecturers)?



21. Did you learn anything new in terms of knowledge and/or skills or techniques? Please give examples.

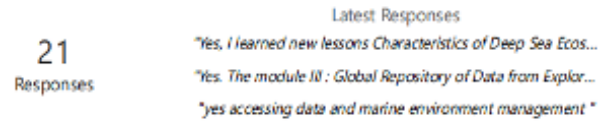

7 respondents (33%) answered **deep sea** for this question.

19. How would you rate the knowledge and expertise of the facilitators?

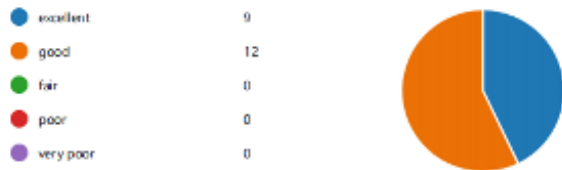

Figure 1. Trainees' responses to the survey

The JTRC training workshop provided a platform for trainees from developing countries to broaden their horizons, and learn and network, helping them increase their understanding and knowledge of JTRC as an effective platform for capacity-building and the transfer of marine technology to developing countries.

The workshop also played a constructive role in facilitating trainees' respective roles in international deep-sea research and management. At the same time, it provided strong support for ISA to continue advancing its capacity development strategy actively.

1.2. Third meeting of the JTRC Steering Committee

On 18 February 2022, the JTRC Steering Committee met for the third time in a hybrid format (online and in-person).

The JTRC Steering Committee reviewed and adopted the documents related to the training activities, including the framework for organizing the JTRC training programmes, the work plan for the first JTRC training workshop and the criteria and process for the selection of participants in the first JTRC training workshop.

The Steering Committee also reviewed and adopted the JTRC annual report for 2021.

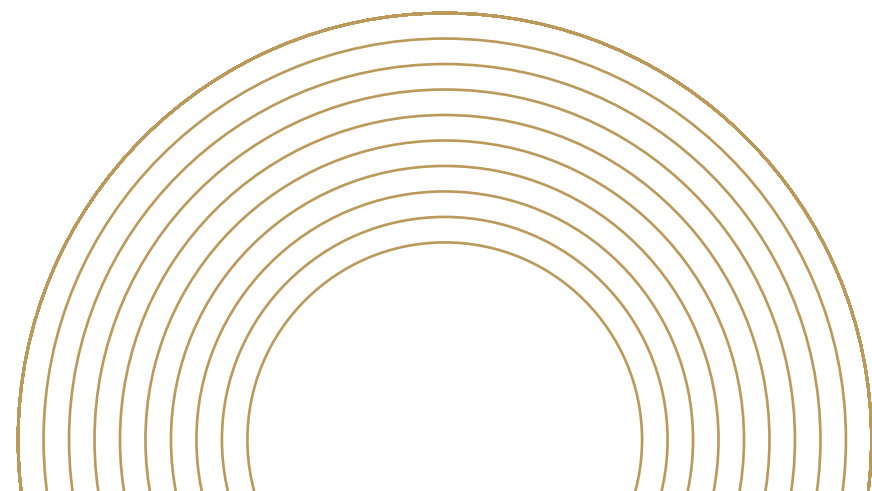
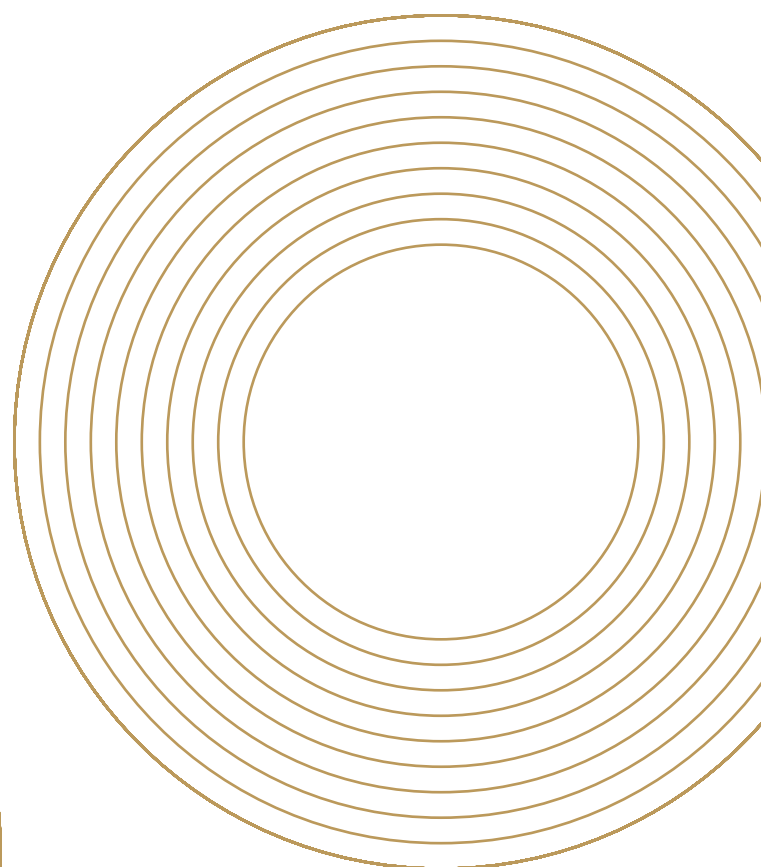
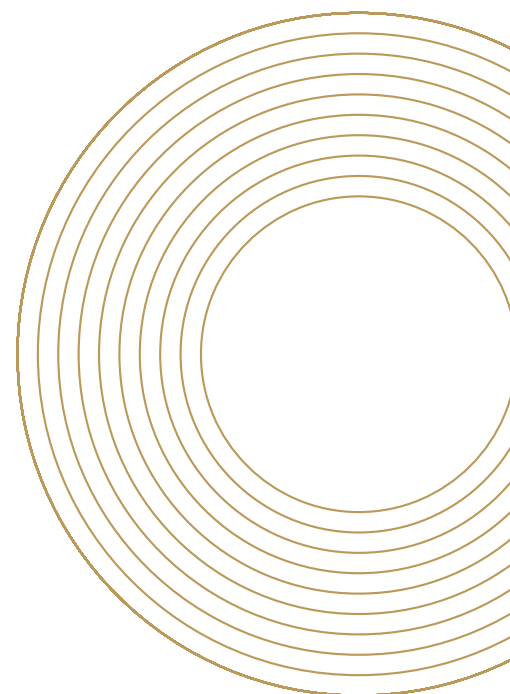

Photo 2. Third meeting of the JTRC Steering Committee

1.3. Design and planning of JTRC research activities

Under the ISA's Action Plan for Marine Scientific Research in support of the United Nations Decade of Ocean Science for Sustainable Development, adopted by the Assembly of ISA in December 2020, the JTRC aims to support the mandate assigned to ISA under the United Nations Convention on the Law of the Sea and the 1994 Agreement, especially concerning the promotion and encouragement of marine scientific research activities in the Area. In that vein, the objective of the JTRC is to become a vehicle that will further advance collaborative research projects related to the latest developments and trends in the Area and international cooperation for developing technical knowledge and research.

This reporting period was dedicated to identifying activities where the JTRC could enhance the work of ISA in promoting marine scientific research, including through the active participation of experts from China and other developing countries. This laid a systematic framework for setting the strategic objectives of joint international scientific research under the JTRC, scientific research project management and implementation, and guidance on applications for the joint research programmes.



02.

FINANCE AND RESOURCES

In 2022, the JTRC spent a total of approximately USD111,500.

The Chinese side spent RMB558,000 (approximately USD80,000), including RMB335,000, funded by the MNR, and RMB223,000, funded by the China Oceanic Development Foundation. The funds were mostly used to organize and implement the first training workshop, trainers' and expert consultation fees, document preparation and staff expenses.

The JTRC also benefited from the support of the ISA Secretariat totaling USD31,500 comprising an in-kind contribution equivalent of staff time by allocating ISA staff members to support the implementation of the JTRC activities (USD27,000) and costs related to the printing of JTRC annual reports in English and Chinese (USD4,500).

03.

WORK PLAN FOR 2023

In 2023, the JTRC will continue to improve its activities to address the different needs identified by the Member States of ISA, particularly developing States.

3.1. The first joint JTRC research programme

The JTRC aims to finalize the JTRC Organizational Framework for Scientific Research Activities and the JTRC's Scientific Research Work Plan for 2023 and broadly communicate the type of programmes, applications and selection processes by 2023.

3.2. The second JTRC training workshop

The second JTRC training workshop is planned for the second half of 2023. It will involve trainees from developing countries participating in on-site training in China. We suggest the training continues focusing on surveying and assessing deep-sea mineral resources, ecosystems, habitats and environmental management. It is expected that the second workshop will involve international experts as lecturers.

Annex 1. JTRC training workshop opening remarks

Michael W. Lodge,
Secretary-General of ISA

Ladies and gentlemen,

Greetings from Kingston, Jamaica.

It is a pleasure to welcome you to the first training workshop on mineral resources, environmental management and data organized under the auspices of the ISA-China JTRC to promote capacity-building and the transfer of marine technology for developing countries, Members of ISA.

Let me begin by thanking the Ministry of Natural Resources of China for its support in organizing this virtual event. I am sure I will speak on behalf of all participants if I say that we would have loved to be able to be in Qingdao, China, for a face-to-face workshop. However, it is a great pleasure to launch this first training workshop of the ISA-China JTRC, and I trust that we will find another opportunity to meet again soon.

Ladies and gentlemen, the duty of ISA to develop and implement mechanisms to build capacity for developing States under its mandate under the UNCLOS and the 1994 Agreement finds its expression in the design of capacity-building initiatives that are meaningful, tangible, efficient, effective and targeted at the needs of developing States, as identified by them.

I attach particular importance to this training workshop as it has been designed to respond to capacity development needs identified by our Member States. It is my firm belief that ISA Member States must be given the opportunity to access high-quality, transformative knowledge, learn with and from each other, and apply their new understanding to real-life scenarios in the Area and beyond to ensure the fully integrated participation of developing States in activities in the Area at all levels.

This workshop will focus on three key areas of activity within ISA's mandate under the UNCLOS and the 1994 Agreement: survey and assessment of mineral resources in the Area, characteristics of deep-sea ecosystems and environmental management and global repository of data from exploration activities in the Area

I wish you a successful and productive training workshop. I very much look forward to hearing about the outcomes of your discussions.

Thank you.

Mr. Wang Hong,

Vice Minister and Administrator, Ministry of Natural Resources (State Oceanic Administration) of the People's Republic of China

Distinguished Secretary-General Michael Lodge, dear experts and trainees,

Today, the first training workshop of ISA - China JTRC officially opened. Due to the complexities and challenges of the COVID-19 pandemic, we are holding the first training workshop of the JTRC online. This speaks volumes about the commitment and determination of the Chinese government and the ISA to jointly promote capacity-building and science and technology exchanges in deep-sea sciences among developing countries. On behalf of the Ministry of Natural Resources, State Oceanic Administration of China, I would like to extend my warm congratulations on the launch of this workshop and my sincere welcome to all the experts and international trainees. I would also like to take this opportunity to express my heartfelt gratitude to the Secretary-General and dear colleagues for their involvement in the construction of the JTRC and for putting together this workshop.

On 9 November 2020, Secretary-General Lodge and I attended the launching ceremony of the ISA - China JTRC. Over the past 18 months, China and the ISA have worked in concert, jointly discussed and contributed to finalizing the institutional set-up and governance system of the JTRC, fine-tuned the strategic directions and priorities of the training activities and improved the curriculum resources and network of expert trainers.

This workshop focuses on the capacity-building needs of developing countries. We have thoughtfully prepared informative and diverse online courses to contribute meaningfully to the capacity enhancement of developing countries to participate in international seabed affairs. Going forward, we will continue to align our interests, deepen joint research, explore new ways of cooperation despite the constraints of COVID-19 and make further progress on training and research.

Over the years, China has been actively engaged in various international seabed activities under the framework of the ISA and has gained rich experience in the survey and exploration of international seabed areas. China has also actively supported and practiced ecological and environmental principles advocated by the ISA. This year marks the 40th anniversary of the adoption of the UNCLOS. As a party to UNCLOS, China has been fully involved in the ocean governance mechanisms under the UNCLOS and United Nations framework and actively supports the work of ocean-related bodies and organizations, including ISA.

China will also organize commemorative events with all parties. We will continue to uphold the spirit of UNCLOS, defend the international order of the oceans based on international law, build consensus on ocean governance, promote international cooperation on the blue economy, jointly build an ocean ecological civilization and a community with a shared future for the oceans, and help achieve the sustainable development goals for the oceans.

I wish all trainees great and useful learning in this training workshop. I look forward to seeing the ISA - China JTRC thrive in the future!

Thank you.

Annex 2. JTRC training workshop agenda

The First JTRC Training Workshop

Mineral resources, environmental management and data

24-26 May 2022

(online)

DAY 1	Tuesday, 24 May 2022: Opening Ceremony	Format
	Chair: Mr. Wu Changbin, Director-General of China Deep Ocean Affairs Administration Opening remarks	
18:30-18:35	Ms. Gu Wu, Director of the JTRC	live
18:35-18:40	Mr. Pan Xinchun, Vice President and Secretary-General of the China Oceanic Development Foundation	live
18:40-18:45	H.E. Mr. Michael Lodge, Secretary-General of ISA	video
18:45-18:50	Mr. Wang Hong, Vice Minister of the Ministry of Natural Resources and Administrator of State Oceanic Administration, China	video
18:50-19:00	Break	
MODULE I	Survey and Assessment of Mineral Resources in the Area	
	Chair: Mr. Liu Feng, Chair of the JTRC Steering Committee	
Lecture 1 19:00-19:25	Overview, distribution characteristics and the status quo of the exploration work of mineral resources in the Area Georgy Cherkashov, Member of LTC, Member of JTRC Steering Committee	live
Group discussion 19:25-19:50	Facilitator: Du Xinguang, China Ship Scientific Research Centre (Group 1) Facilitator: Shen Honglei, China University of Mining and Technology (Group 2) Facilitator: Filipa Marques, Chief Research Officer, International Sharing University (Group 3)	live
19:50-20:10	Break	
Lecture 2 20:10-20:35	Assessment methodologies and investigation techniques of three types of mineral resources (PMN, PMS and CFC) in the Area Prof. Tao Chunhui, MNR China, Second Institute of Oceanography	live
Group discussion 20:35-21:00	Facilitator: Du Xinguang, China Ship Scientific Research Centre (Group 1) Facilitator: Shen Honglei, China University of Mining and Technology (Group 1) Facilitator: Ren Xiangwen, MNR China, First Institute of Oceanography (Group 1)	live
21:00-21:20	Break	

Lecture 3 21:20-21:45	Status quo and development of mining technology for mineral resources in the Area Prof. Li Xiangyang, COMRA	live
Group discussion 21:45-22:10	Facilitator: Du Xinguang, China Ship Scientific Research Centre (Group 1) Facilitator: Shen Honglei, China University of Mining and Technology (Group 2) Facilitator: Ren Xiangwen, MNR China, First Institute of Oceanography (Group 3)	live
22:10-22:15	Closing remarks Mr. Liu Feng, Chair of the JTRC Steering Committee	live
DAY 2	Wednesday, 25 May 2022 Chair: Prof. Qian Peiyuan, Hong Kong University of Science and Technology	
MODULE II	Characteristics of Deep-Sea Ecosystems and Environmental Management	
Lecture 1 18:30-18:55	Scientific knowledge of deep-sea ecosystems and habitats in the Area Malcolm Clark, Member of LTC	live
Group discussion 18:55-19:20	Facilitator: Sun Jin, Ocean University of China (Group 1) Facilitator: Lan Yi, Hong Kong University of Science and Technology (Group 2) Facilitator: Liu Qian, MNR China, Second Institute of Oceanography (Group 3)	live
19:20-19:40		
Lecture 2 19:40-20:05	Protection of the marine environment in the Area through regional environmental management planning and impact assessments Malcolm Clark, Member of LTC	live
Group discussion 20:05-20:30	Facilitator: Sun Jin, Ocean University of China (Group 1) Facilitator: Lan Yi, Hong Kong University of Science and Technology (Group 2) Facilitator: Liu Qian, MNR China, Second Institute of Oceanography (Group 3)	live
20:30-20:50	Break	
Lecture 3 20:50-21:15	Marine scientific research to enhance knowledge of deep-sea biodiversity Prof. Qian Peiyuan, Hong Kong University of Science and Technology	live
Group discussion 21:15-21:40	Facilitator: Sun Jin, Ocean University of China (Group 1) Facilitator: Lan Yi, Hong Kong University of Science and Technology (Group 2) Facilitator: Liu Qian, MNR China, Second Institute of Oceanography (Group 3)	live
22:10-22:15	Closing remarks Prof. Qian Peiyuan, Hong Kong University of Science and Technology	live

DAY 3		Thursday, 26 May 2022	
		Chair: Shi Xianpeng, National Deep Sea Centre of China	
MODULE III	Global Repository of Data from Exploration Activities in the Area		
Lecture 1	Structure and functionalities of DeepData		live
18:30-18:55	Sheldon Carter, Database Manager, ISA		
Group discussion	Facilitator: Liu Ying, COMRA (Group 1)		live
18:55-19:20	Facilitator: Zheng Hao, Changsha Research Institute of Mining and Metallurgy, China Minmetals Corporation (Group 2)		
	Facilitator: Sun Miao, National Marine Data and Information Service of China (Group 3)		
19:20-19:40	Break		
Lecture 2	Reporting templates and database management strategy of DeepData		live
19:40-20:05	Ulrich Schwarz-Schampera, Programme Manager - Mining Geology, ISA, and Sheldon Carter, Database Manager, ISA		
Group discussion	Facilitator: Liu Ying, COMRA (Group 1)		live
20:05-20:30	Facilitator: Zheng Hao, Changsha Research Institute of Mining and Metallurgy, China Minmetals Corporation (Group 2)		
	Facilitator: Sun Miao, National Marine Data and Information Service of China (Group 3)		
20:30-20:50	Break		
Lecture 3	Case study of data management of survey activities in the Area		live
20:50-21:15	Han Chunhua, National Marine Data and Information Service of China		
Group discussion	Facilitator: Liu Ying, COMRA (Group 1)		live
21:15-21:40	Facilitator: Zheng Hao, Changsha Research Institute of Mining and Metallurgy, China Minmetals Corporation (Group 2)		
	Facilitator: Sun Miao, National Marine Data and Information Service of China (Group 3)		
21:40-21:45	Closing remarks		live
	Dr. Shi Xianpeng, National Deep Sea Centre of China		
21:45-21:50	Workshop closing remarks		
	Dr. Marie Bourrel-McKinnon, Senior Policy Officer and Special Assistant to the Secretary-General of the ISA		



中国-国际海底管理局
联合培训和研究中心

A vertical decorative line with a white top section, a yellow middle section, and a red bottom section.

2022年 年度报告

前言

我非常荣幸地向大家介绍中国-国际海底管理局联合培训和研究中心(“联合中心”)2022年的年度报告。该中心在运行的第二年成功组织了首次具体活动。

2022年5月,联合中心举办了第一次培训班。它汇集了来自海洋生物学、海洋学、地质学和技术等各个领域的顶尖专家,分享他们在深海勘探方面的知识、见解和实践经验。这次培训班为学员们提供了一个非常好的平台,使他们能够讨论和研究《联合国海洋法公约》及1994年《协定》所规定的国际海底管理局任务范围内的三个关键领域:区域矿产资源的调查与评估、深海生态系统的特征与环境管理以及“区域”内勘探活动的全球数据库。来自20个不同国家的50多名学员参加了此次活动,其中45%来自最不发达国家、内陆发展中国家和小岛屿发展中国家。我很高兴其中大部分学员表示此次活动使他们受益良多。

我们满怀热情和乐观地期待着下一年的到来,相信我们将继续做出重要贡献。

迈克尔·洛奇

国际海底管理局秘书长



前言

2022年,在双方的共同努力下,中国-国际海底管理局联合培训和研究中心(“联合中心”)克服全球新冠疫情的影响,通过线上方式成功举办了自中心成立以来的第一期培训班,邀请国际海底领域的著名专家为来自20个发展中国家的50余名学员提供了内容丰富、时效性高、交互性强的培训课程,为提升发展中国家参与国际海底事务的能力做出了积极贡献。同时,也为双方今后开展联合研究奠定了坚实基础。

未来,中方愿与国际海底管理局一道支持联合中心的建设和发展,加强与世界各国的友好合作,推动对国际海底区域的认知更全面、更系统、更深入。我们期待联合中心在指导委员会的指导下,汇聚全球资源,邀请知名国际师资,为广大发展中国家学员提供更好培训活动,同时携手国际专业团队就深海领域重大科学问题开展联合研究,深化务实合作!

愿我们共同努力,推动国际海底区域工作迈上新台阶!

王宏

中国自然资源部副部长,国家海洋局局长



国际海底管理局-中国联合培训研究中心2022年

2020年11月正式投入运行的中国-国际海底管理局联合培训和研究中心（“联合中心”）去年开展了其第二年工作。在国际海底管理局（“海管局”）和中国自然资源部的密切参与和积极推动下，联合中心取得了稳步发展。

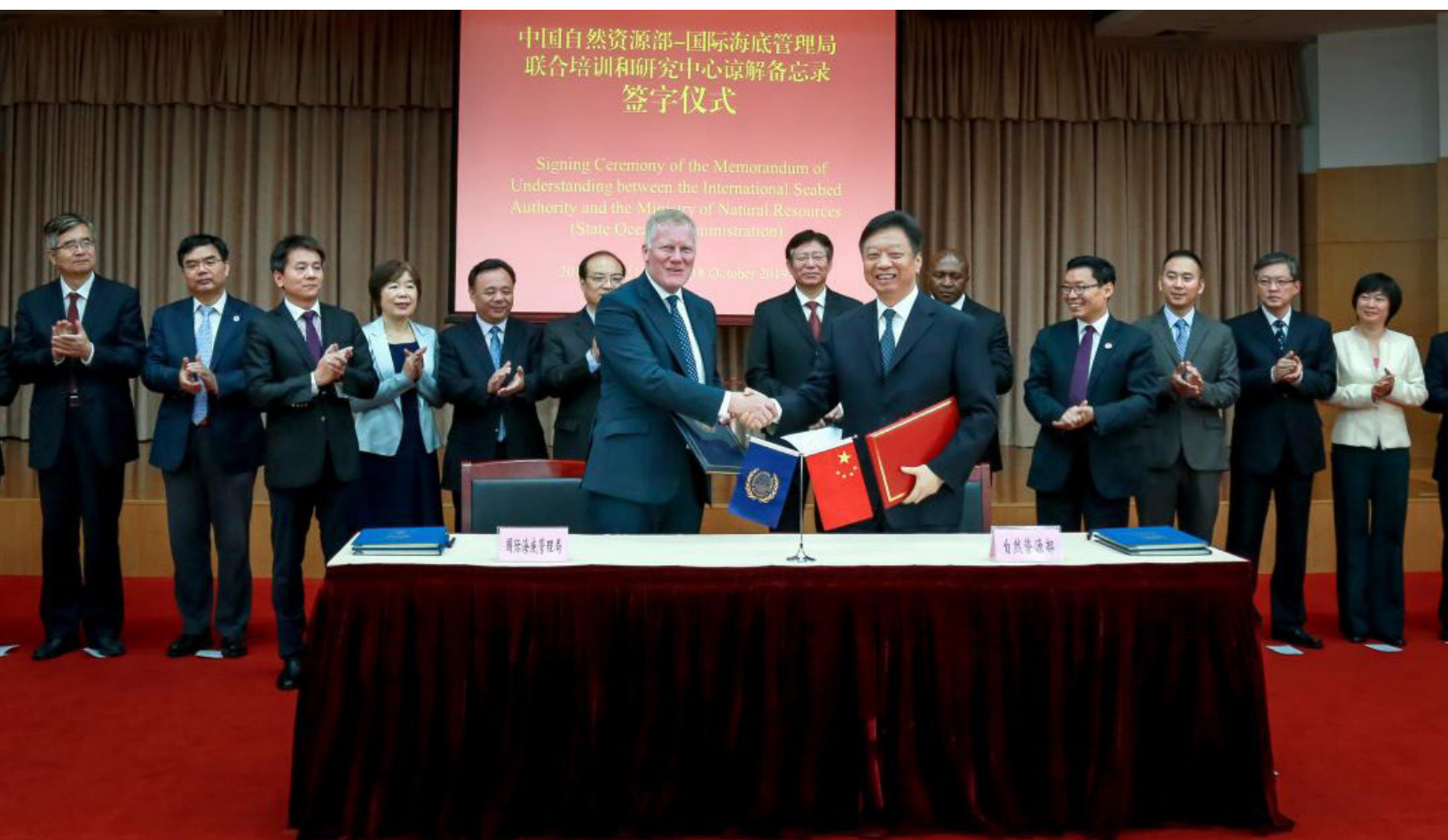

01.

2022年活动亮点

1.1. 联合中心第一期培训班

联合中心第一次培训班于2022年5月24日至26日举行，培训内容包括矿产资源的调查和评估、深海生态系统的特点和环境管理，以及“区域”内勘探活动的全球数据库。

来自20个国家的55名学员参加了培训，其中包括45%的最不发达国家、内陆发展中国家和小岛屿发展中国家国民，以及45%的女性。

海管局秘书长迈克洛奇阁下在欢迎辞中重申，海管局非常重视伙伴关系，通过开展有意义的的能力发展活动来满足海管局发展中成员国的重点需求。

“我特别重视这次培训研讨会，它旨在满足我们成员国确定的能力发展需求。我坚信，海管局成员国应该有机会获得高质量的变革性知识，相互学习，并将他们的新理解应用于“区域”内外的现实场景，确保发展中国家充分综合参与“区域”内的各层次活动。”

中国自然资源部副部长、国家海洋局局长王宏先生表示：“在全球新冠疫情依然复杂严峻的情况下，我们以线上课程的方式举办第一期培训班，表明了中国政府与国际海底管理局在共同促进发展中国家深海领域能力建设和海洋科学与技术交流的意愿和决心。”（完整致辞见附件1）。

为期三天的培训班包括九个讲座。授课专家来自海管局秘书处、法律与技术委员会（LTC）、香港科技大学、中国大洋矿产资源研究与开发协会（COMRA）办公室、中国自然资源部第二海洋研究所和中国国家海洋信息中心。来自中国自然资源部第一海洋研究所、五矿集团长沙矿冶研究院、中国海洋大学、中国船舶科学研究中心和矿业大学的10名年轻专家在分组讨论中担任了主持人。来自不同国家的学员就培训主题进行了积极和生动的小组讨论和互动交流（议程见附件2）。



The First Training Workshop of ISA - China Joint Training and Research Center Mineral resources, environmental management and data



Photo 1.
照片1 培训班学员和授课专家

培训班结束后，海管局秘书处对培训活动在发展中国家能力建设方面的质量、实用性和价值进行了调查。21名国际学员回答了这项定制化的调查。超过90%的受访者评价该培训班为“优秀”或“良好”。他们还表示，

此次培训班为发展中国家能力建设需要量身设计，所涉及的主题涉及该领域的前沿和热点问题，培训方案内容丰富，形式多样，对深海学术领域的国际研究和管理产生积极影响。

17. How would you rate the teaching and learning methodology the experts and facilitators applied during the training workshop?



20. How would you rate the quality of the training materials?

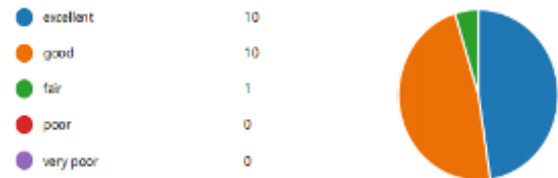

18. How would you rate the knowledge and expertise of the experts (lecturers)?

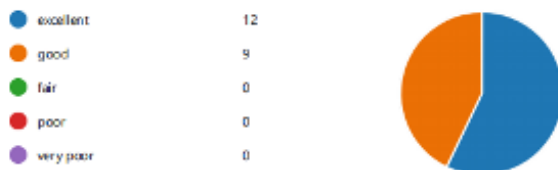

21. Did you learn anything new in terms of knowledge and/or skills or techniques?
Please give examples.

21
Responses

Latest Responses

"Yes, I learned new lessons Characteristics of Deep Sea Ecos..."

"Yes. The module 10 : Global Repository of Data from Explor..."

"yes accessing data and marine environment management "

7 respondents (33%) answered **deep sea** for this question.



19. How would you rate the knowledge and expertise of the facilitators?

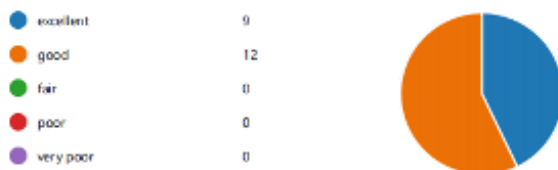

Figure 1.
图1. 学员的调查结果

联合中心培训班为发展中国家参训人员提供了一个开拓视野、学习和建立网络的平台,使他们提升了对将联合中心作为能力建设和向发展中国家转让海洋技术的有效平台

的理解和认识。培训班还在促进学员在国际深海研究和管理方面发挥了建设性作用。同时,它为海管局继续积极推进能力发展战略提供了有力支持。

1.2. 联合中心指导委员会第三次会议

2022年2月18日,联合中心指导委员会以混合会议形式(线上与线下结合)举行了第三次会议。

联合中心指导委员会审查并通过了培训相关文件,包括联合中心培训活动组织框架、联合中心第一期培训班工作计划以及联合中心第一期培训班参与者的遴选标准和流程。

指导委员会还审查并通过了联合中心2021年年度报告。

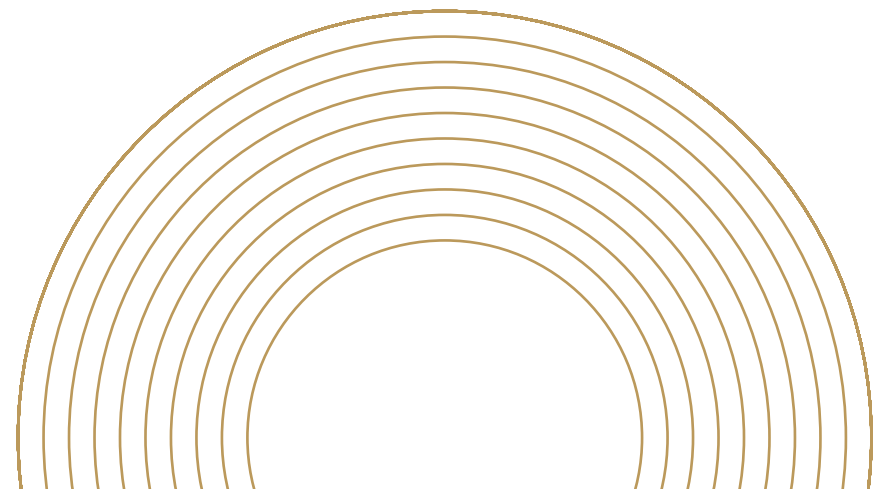
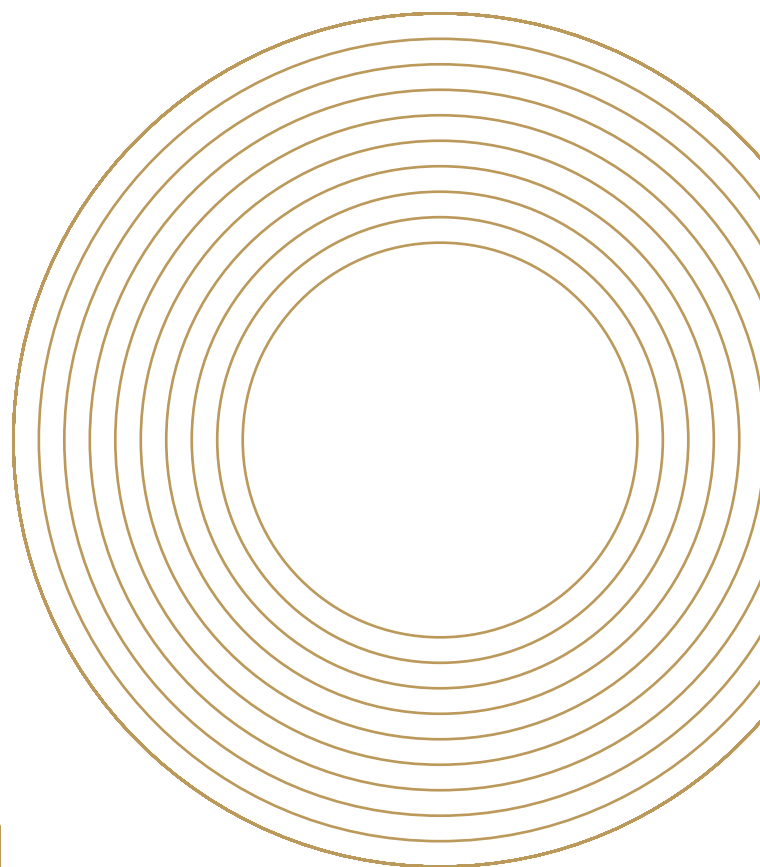
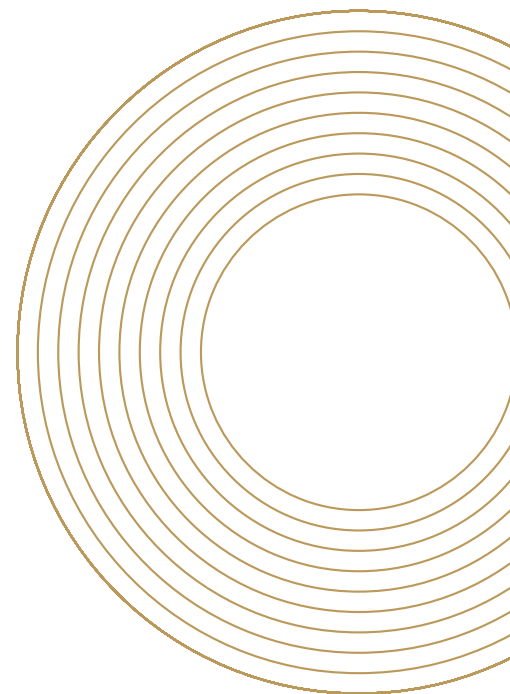

Photo 2. Third meeting of the JTRC Steering Committee
照片2 联合中心指导委员会第三次会议

1.3. 联合中心研究活动的设计和规划

根据国际海底管理局大会2020年12月通过的支持联合国海洋科学促进可持续发展十年的海洋科学研究行动计划,联合中心旨在支持《联合国海洋法公约》和1994年《协定》赋予海管局的使命,特别是促进和鼓励“区域”内的海洋科学研究活动。因此,联合中心的工作目标是进一步推动与“区域”最新发展和趋势有关的合作研究项目,以及技术知识和研究发展的国际合作。

本报告期致力于进一步明确联合中心在加强海管局促进海洋科学研究方面的工作内容,并确保中国和其他发展中国家专家积极参与。这为制定联合中心框架下的国际联合科学研究的战略目标、科学研究项目的管理和实施以及联合研究项目指南奠定了系统框架。



02.

资金和资源

2022年,联合中心共计使用经费约111500美元。

中方共支出人民币55.8万元(约合8万美元),其中自然资源部资助经费人民币33.5万元、中国海洋发展基金会资助经费人民币22.3万元,主要用于第一期培训班组织实施、教师授课、专家咨询、文档准备以及人员经费等。

联合中心还受益于来自海管局秘书处共计31500美元的支持,其中包括分配海管局工作人员支持联合中心工作,相当于工作人员时间的实物支持(27000美元),以及联合中心年度报告中英版印刷费用(4500美元)。

03.

2023年工作计划

2023年,联合中心将继续面向海管局成员国特别是发展中国家确定的各项需求,积极推动开展相关工作。

3.1 联合中心第一期研究项目

2023年,联合中心将确定科学研究活动组织框架和2023年科学研究工作计划,并就研究项目的组织方式、申请和遴选过程等进行广泛沟通。

3.2 联合中心第二期培训班

2023年下半年,联合中心将在中国通过现场培训的方式面向发展中国家学员举办联合中心第二期培训班,培训班将继续侧重于深海矿产资源、深海生态系统与典型生境的调查和评估以及环境管理等内容,将邀请国际专家参与第二期培训班的培训活动。

附件一 培训班开幕仪式致辞

迈克尔·洛奇

国际海底管理局秘书长

女士们、先生们：

我在牙买加金斯敦向大家致以问候。

欢迎您参加由中国-海管局联合培训和研究中心主办的第一期矿产资源、环境管理和数据培训班，以促进海管局成员国发展中国家的能力建设和海洋技术转让。

首先，我要感谢中国自然资源部对此次线上活动的支持。如果我说我们很想在中国青岛举办一个面对面的培训班，我相信所有与会者都会同意我的想法。无论如何，很高兴中国-海管局联合培训和研究中心第一期培训班启动，我相信我们会很快找到再次见面的机会。

女士们、先生们，根据《联合国海洋法公约》和1994年《协定》的授权，国际海底管理局有义务制定和执行针对发展中国家建设能力的机制，这体现在制定有意义、切实、高效、有效的能力建设举措，并针对发展中国家的需求。

我特别重视这次培训班，因为它旨在满足我们成员国确定的能力发展需要。我坚

信，必须让海管局成员国有机会获得高质量的变革性知识，相互学习，并将其新的理解应用于“区域”内外的现实情况，以确保发展中国家充分综合参与“区域”的各层次活动。

该培训班将面向国际海底管理局根据《联合国海洋法公约》和1994年《协定》的规定开展的三个关键活动领域：“区域”内矿产资源的调查和评估、深海生态系统的特点和环境管理以及“区域”勘探活动数据的全球储存库。

我祝愿培训班取得圆满成功。我非常期待听到你们讨论的成果。

非常感谢。

王宏

中国自然资源部副部长, 国家海洋局局长

尊敬的迈克·洛奇秘书长,
各位专家和学员:

大家好!

中国-国际海底管理局联合培训和研究中心第一期培训班今天正式开班了!在全球新冠疫情依然复杂严峻的情况下,我们以线上课程的方式举办第一期培训班,表明了中国政府与国际海底管理局在共同促进发展中国家深海领域能力建设和海洋科学与技术交流的意愿和决心。在此,请允许我代表中国自然资源部(国家海洋局)对培训班开班表示热烈祝贺,对各位专家和国际学员表示诚挚的欢迎,并借此机会向秘书长先生和各位同仁在联合培训和研究中心建设、筹办好此次培训班过程中所付出的努力表示衷心的感谢。

2020年11月9日,我和迈克洛奇秘书长共同参加了中国-国际海底管理局联合培训和研究中心启动仪式。一年半以来,双方同心协力,共商共建,推动中心机构设置和制度建设,探讨完善培训活动的战略方向和重点目标,不断打磨课程资源体系和培训专家体系。本次培训班面向发展中国家能力建设需求,精心准备了内容丰富、形式多样的线上

课程,力求为提升发展中国家参与国际海底事务的能力做出有益贡献。下一步,我们还将继续加强对接,深化联合研究方面的工作,探索疫情背景下新的合作方式,使培训和研究工作不断取得实效。

多年来,中国始终积极参与国际海底管理局框架下的各类国际海底活动,在矿区调查、勘探方面积累了丰富经验,并积极支持和践行国际海底管理局所倡导的生态环保理念。今年是《联合国海洋法公约》通过40周年,中国作为公约缔约国全面参与公约及联合国框架下的海洋治理机制,积极支持包括国际海底管理局在内的涉海机构和组织的工作。中方也将与各方一道开展相关的纪念活动,继续秉持公约精神,捍卫以国际法为基础的国际海洋秩序,凝聚海洋治理共识,推动蓝色经济合作,共建海洋生态文明,构建海洋命运共同体,助力实现海洋可持续发展目标。

最后,预祝各位学员们在本次培训班中学有所获、学有所用,也祝中国-国际海底管理局联合培训和研究中心越办越好!

谢谢大家!

附件2 联合中心第一期培训班日程

矿产资源, 环境管理与数据

2022年5月24日至26日

线上形式

第一天	2022年5月24日(星期二):开幕式	形式
	主持人: 邬长斌先生, 中国大洋事务管理局局长 致辞	
18:30-18:35	联合中心主任古妩女士致辞	在线
18:35-18:40	中国海洋发展基金会副理事长、秘书长潘新春先生致辞	在线
18:40-18:45	国际海底管理局秘书长迈克·洛奇先生致辞	视频
18:45-18:50	中国自然资源部副部长、国家海洋局局长王宏先生致辞	视频
18:50-19:00	休息	
模块I	“区域”内矿产资源调查与评价 主持人: 刘峰先生, 联合中心指导委员会主席	
讲座1	介绍了本区矿产资源的概况、分布特征及勘查工作现状	在线
19:00-19:25	乔治·切尔卡绍夫博士, 海管局法技委成员, 联合中心指导委员会委员	
小组讨论	主持人: 杜新光, 中国船舶科学研究中心(第一组)	在线
19:25-19:50	主持人: 沈洪垒, 中国矿业大学(第二组) 主持人: 菲利帕·马库斯, 国际共享大学首席研究官(第三组)	
19:50-20:10	休息	
讲座2	“区域”内三类矿产资源(多金属结核、多金属硫化物、富钴结壳)的评价方法和调查技术	在线
20:10-20:35	陶春晖研究员, 中国自然资源部第二海洋研究所研究员	
小组讨论	主持人: 杜新光, 中国船舶科学研究中心(第一组)	在线
20:35-21:00	主持人: 沈洪垒, 中国矿业大学(第二组) 主持人: 任向文, 中国自然资源部第一海洋研究所(第三组)	
21:00-21:20	休息	

讲座3	“区域”内矿产资源开采技术现状与发展	在线
21:20-21:45	李向阳研究员, 中国大洋协会办公室	
小组讨论	主持人: 杜新光, 中国船舶科学研究中心(第一组)	在线
21:45-22:10	主持人: 沈洪垒, 中国矿业大学(第二组)	
	主持人: 任向文, 中国自然资源部第一海洋研究所(第三组)	
22:10-22:15	闭幕词	在线
	刘峰先生, 联合中心指导委员会主席	
DAY 2	2022年5月25日, 星期三	
	主持人: 钱培元教授, 香港科技大学	
模块 II	深海生态系统和环境管理的特点	
讲座1	“区域”深海生态系统和生境的科学知识	在线
18:30-18:55	马尔科姆·克拉克, 海管局法技委委员	
小组讨论	主持人: 孙进, 中国海洋大学(第一组)	在线
18:55-19:20	主持人: 兰奕, 香港科技大学(第二组)	
	主持人: 刘倩, 中国自然资源部第二海洋研究所(第三组)	
19:20-19:40	休息	
讲座2	通过“区域”环境管理计划和影响评价保护“区域”海洋环境	在线
19:40-20:05	马尔科姆·克拉克, 海管局法技委委员	
小组讨论	主持人: 孙进, 中国海洋大学(第一组)	在线
20:05-20:30	主持人: 兰奕, 香港科技大学(第二组)	
	主持人: 刘倩, 中国自然资源部第二海洋研究所(第三组)	
20:30-20:50	休息	
讲座3	开展海洋科学研究, 增进对深海生物多样性的认识	在线
20:50-21:15	钱培元, 香港科技大学教授	
小组讨论	主持人: 孙进, 中国海洋大学(第一组)	在线
21:15-21:40	主持人: 兰奕, 香港科技大学(第二组)	
	主持人: 刘倩, 中国自然资源部第二海洋研究所(第三组)	
21:40-21:45	闭幕词	在线
	钱培元, 香港科技大学教授	

DAY 3	2022年5月26日星期四	
	主持人:史先鹏博士, 中国国家深海基地管理中心	
MODULE III	“区域”内勘探活动数据的全球储存库	
讲座1	DeepData的结构和功能 谢尔顿·卡特, 国际海底管理局数据库项目主管	在线
小组讨论	主持人:刘颖, 中国大洋协会办公室(第一组)	
18:55-19:20	主持人:郑浩, 中国五矿集团公司长沙矿冶研究院(第二组) 主持人:孙苗, 中国国家海洋信息中心(第三组)	
19:20-19:40	休息	
讲座2	DeepData的报表模板和数据库管理策略 Ulrich Schwarz-Schampera, 国际海底管理局采矿地质学项目经理和谢尔顿·卡特, 国际海底管理局数据库项目主管	在线
19:40-20:05		
小组讨论	主持人:刘颖, 中国大洋协会办公室(第一组)	在线
20:05-20:30	主持人:郑浩, 中国五矿集团公司长沙矿冶研究院(第二组) 主持人:孙苗, 中国国家海洋信息中心(第三组)	
20:30-20:50	休息	
讲座3	“区域”内调查活动的管理案例研究 韩春花, 中国国家海洋信息中心	在线
20:50-21:15		
小组讨论	主持人:刘颖, 中国大洋协会办公室(第一组)	在线
21:15-21:40	主持人:郑浩, 中国五矿集团公司长沙矿冶研究院(第二组) 主持人:孙苗, 中国国家海洋信息中心(第三组)	
21:40-21:45	闭幕词 史先鹏博士, 中国国家深海基地管理中心	在线
21:45-21:50	培训班闭幕词 玛丽·伯勒尔-麦金农博士, 国际海底管理局高级政策干事兼秘书长特别助理	在线

GALLERY

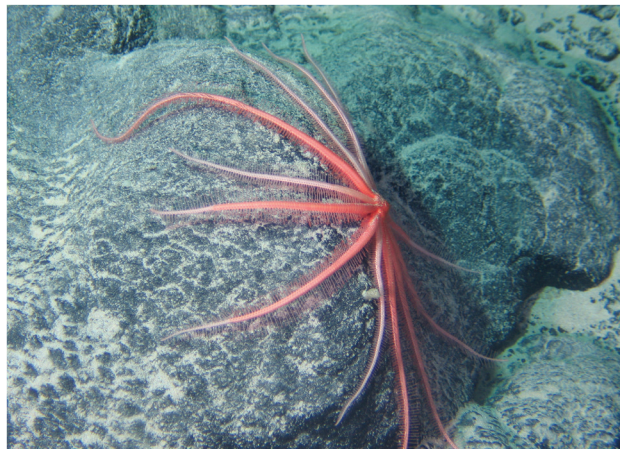
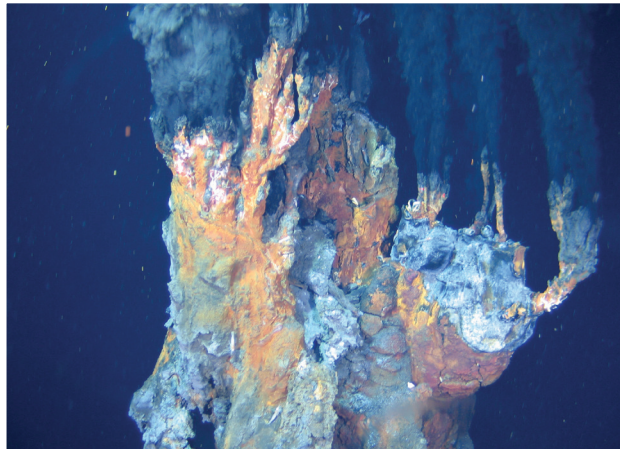
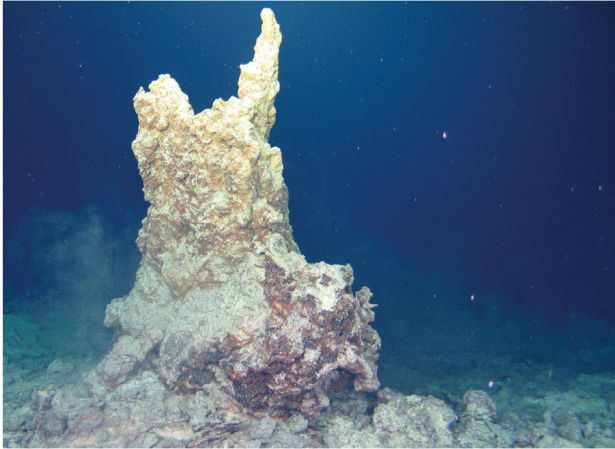
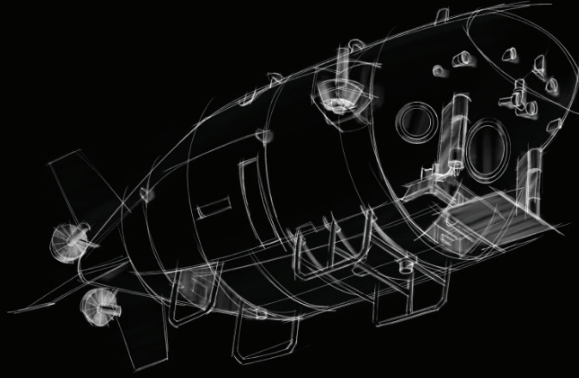



14 - 20 Port Royal Street
Kingston, Jamaica
Tel: +1 (876) 922-9105
www.isa.org.jm